

Inventor 2009 Subscription Bonus Pack

Autodesk has just released a new Bonus Pack for Inventor 2009 that increases the functionality of the software for clients on valid current Product Subscription. These tools are aimed at some of the wishes users have been craving for that do not require a complete revision in the software like a Service Pack or a yearly release would dictate. However, these tools will be in the next release of Inventor so you can rely on them being there whereas user add-ins which are always up in the air as to whether or not they will work in the next version.

Enhancements were made to the part, assembly, and drawing mode as well as some global changes. The purpose of this document is to introduce you to them, where to find them and how to use a few of them.

Who, What, and Where?

The Inventor Subscription Bonus Pack can be found in the Subscription Portal ([link](#)). This is the portal in which your company's contact logs in for support, product updates, and news. The contact is defined by who you set up with your reseller and a company usually only has one contact. The bonus pack is available in both 32 and 64 bit versions and requires the software to be updated to SP1 for Inventor ([link](#)). Also you cannot have the UI Technology Preview from Labs installed in order for the bonus pack to install, but iMap, Shrinkwrap, Sustainable Materials, and Advanced Simulation Preview still work alongside the new enhancements.

Part

Create Parameters on the fly when dimensioning:

Sketch your geometry and dimension it. In the edit dimension dialog box, type in a new name for the parameter and use an equal sign to assign your value for the parameter. This only works for the sketch environment where you create the majority of your intelligence. This will automatically replace the "d" value that normally appears with your new parameter name.

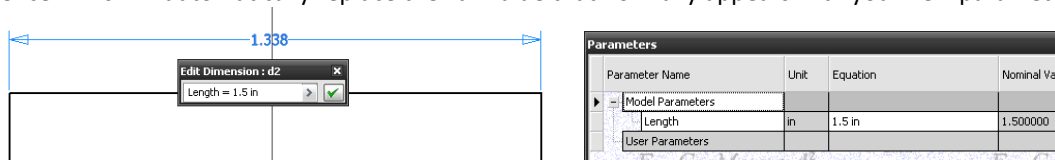

Sketch Scale and Rotate:

Used for applying a scale or rotate command and staying active in the command to prevent having to restart it.

Simplified Loft Selection:

Right click menu adds options for adding placed sections, centerlines, rails, and by default normal sections. This allows the user to focus more on the loft and less on the dialog box.

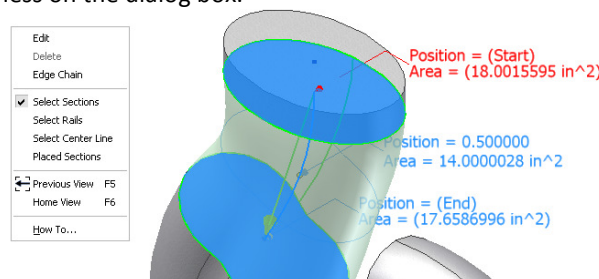

iFeatures:

Specify the normal for ifeatures and create ifeatures from iparts which in turn creates table driven ifeatures automatically. This allows greater productivity when placing and creating ifeatures. When an ipart is selected for use in an ifeature it will automatically create the size parameters to be list limited and values populated to the same value in the table for the ipart.

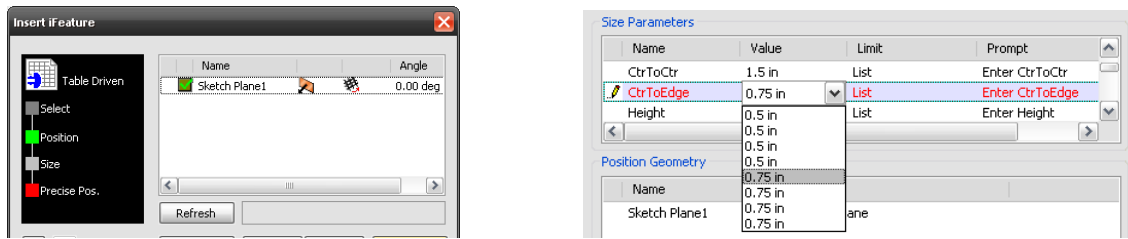

Assemblies

BOM Editor:

I would almost call this next item a functional reprogramming of the BOM Editor. First off we have the ability to ctrl or shift select items in the window for editing. New editing commands available are the option to capitalize the fields, perform a find, copy, replace and paste. The other wonderful enhancement here is the cross-reference highlight in the assembly corresponding to the selection in the window.

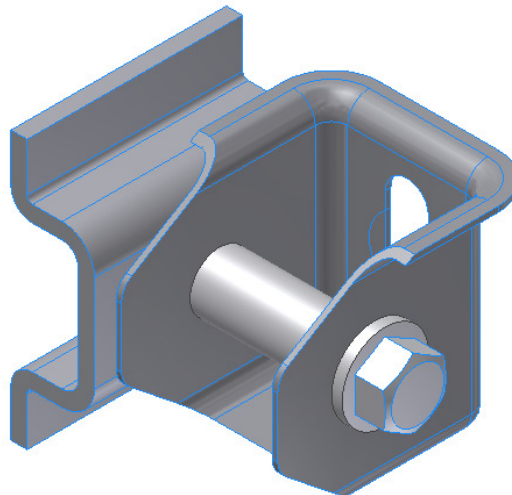
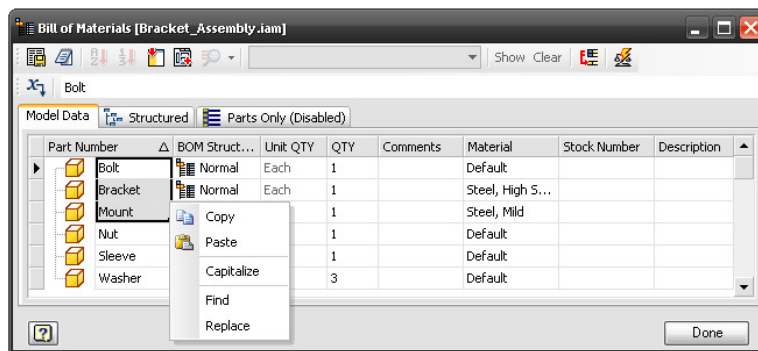

The rest of the enhancements to the assembly environment pertain to some other changes that affect more than one area of the software.

Drawings

Arrange Dimensions:

A new command that allows user to select multiple dimensions that have already been placed and arrange them so that they are all spaced and placed evenly. The command is also added to the right click menu.

- Start the command
- Select the dimensions
- Right mouse button and choose “Contour Entity “
- Left click to lay in your new arrangement.

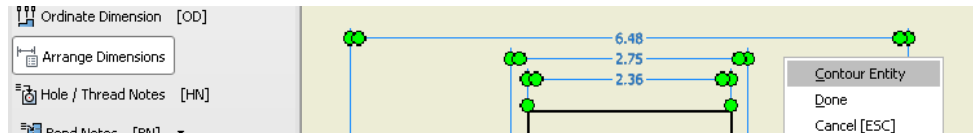

Selection Filter:

This is a new set of options for the selection filter for overlapping dimensions or precise selection of certain dimensions.

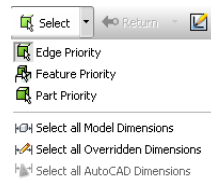

Refresh Copied Properties:

- Turn on copy model iproperties from the drawing tab of document settings
- Select which model iproperties to copy to your drawing iproperties
- Use the Update Copied Model iProperties from the tools menu or add it to your panel bar if you use this a lot.



Balloons:

Alignment and snapping is used during placement.

Project Geometry:

Use of the project geometry tool inside a sketch on a view functions similar to the normal part sketch environment.

Edit Dimension:

Placement of dimensions now has the option to edit when placed. This will be a toggle available in application option's drawing tab and the edit dialog box as well.

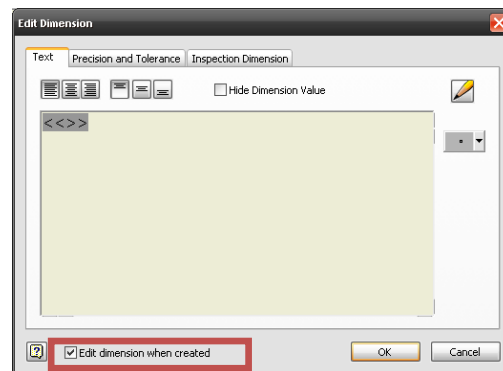
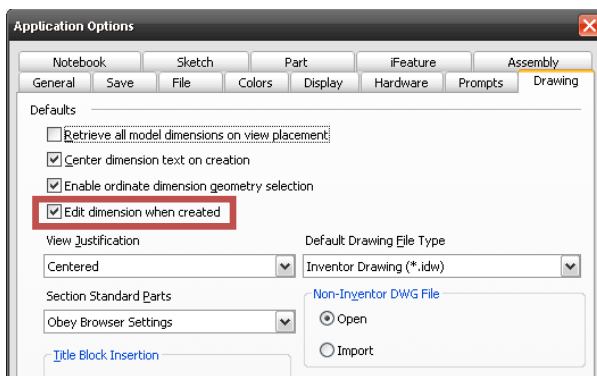

All Over

Origin Labels:

Many users have difficulty understanding the origin Indicator in the part and assembly modes. The old rule of thumb used to be XYZ = RGB. But now we have visual labels to go along with the old adage.

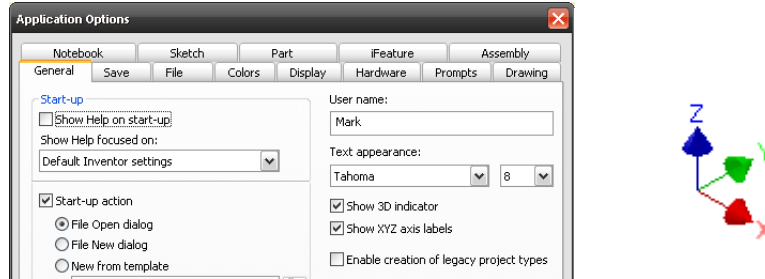

Auto-Save (not quite):

This enhancement has always been the subject of much debate from AutoCAD users. Those who have been using Inventor for some time understand why not to have an auto-save. So now we have a compromise. It is a reminder that can be set on the save tab of application options to remind the user to save the current file to maintain session work.

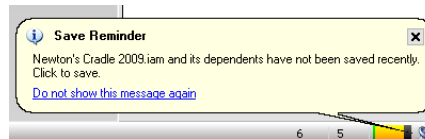

Open Drawing:

This is a new option to the right click functionality when you do so on a part file. This can be accomplished in a part file or an assembly file. The command will find the corresponding drawing file to the part file. If no drawing file exists you will be prompted with a file open instead.

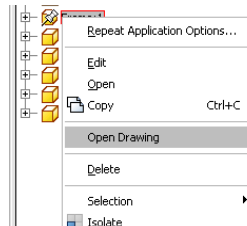

About the Author: Mark Allen Flayler

Mark is an Application Engineer with IMAGINiT Technologies, specializing in manufacturing environments. He has implemented the Autodesk Manufacturing products with several industries including the blow/injection molding, automotive, and custom machinery markets. Inventor has been a profound augmentation in his abilities allowing him to bring 3D digital prototyping to the forefront of the industries with which he has interacted. He has extensive experience and a comprehensive understanding of the technical, practical business and human dimensions of implementation. He is an effective and skillful communicator, consulting with his clients to help achieve their business objectives. Mark is an ATC certified instructor and he provides training, support, and implementation. Mark is PSE and ATC certified in AutoCAD®, AutoCAD® Mechanical, AutoCAD® Electrical, Autodesk® Data Management, and Autodesk® Inventor™.



All brand names, product names, or trademarks belong to their respective holders.
 IMAGINiT Technologies is not responsible for typographical or graphical errors that may appear in this document.

© 2008 IMAGINiT Technologies